

Establishment of RWMS for the City of Novi Sad and Municipalities of Bačka Palanka, Bački Petrovac, Beočin, Žabalj, Srbobran, Temerin and Vrbas



REPUBLIC OF SERBIA
MINISTRY OF EUROPEAN INTEGRATION



The design and construction of the Regional Waste Management Center in City of Novi Sad



REPUBLIC OF SERBIA
MINISTRY OF EUROPEAN INTEGRATION



Project Area

The RWMC shall serve to the **City of Novi Sad** and municipalities of **Bačka Palanka, Bački Petrovac, Beočin, Žabalj, Srbobran, Temerin and Vrbas**. These municipalities belong to the South Bačka administrative district of AP Vojvodina and covers the area of 2,861 km² with 543,210 inhabitants (Census 2022).

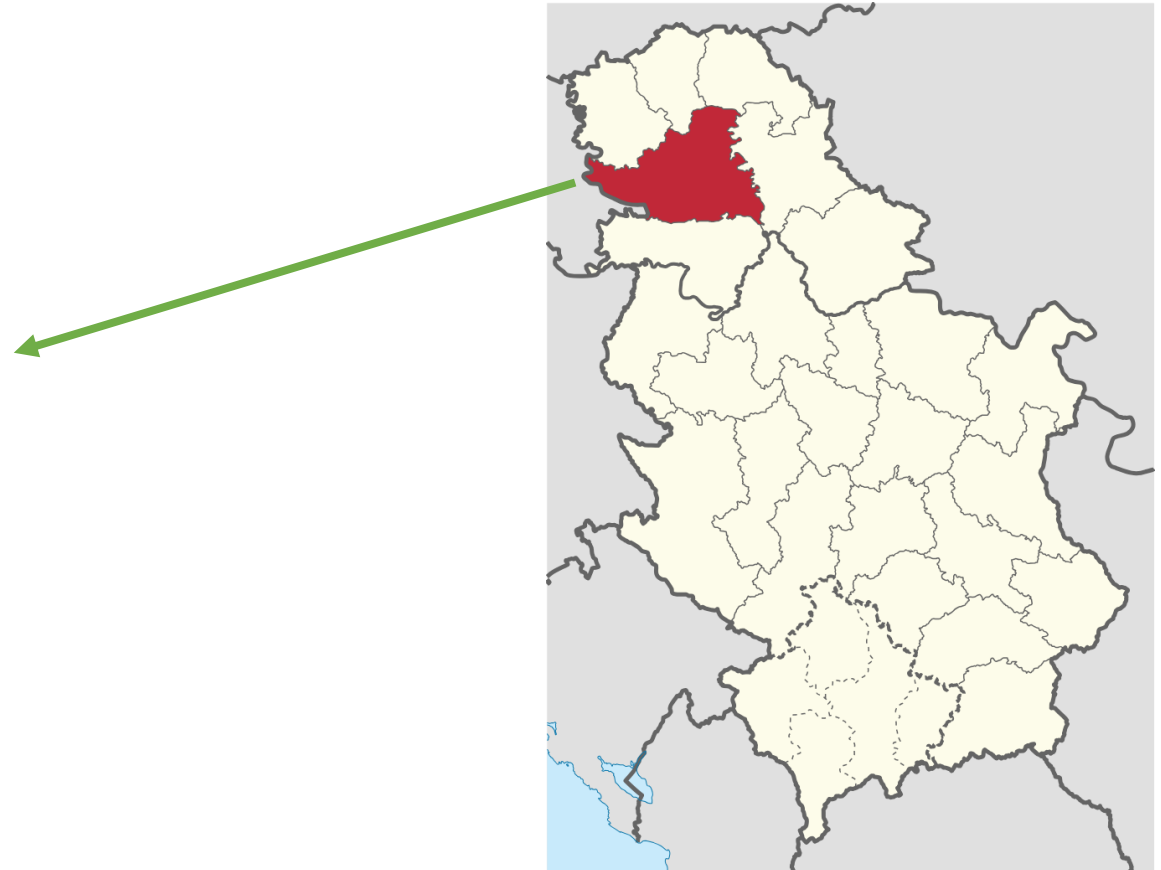
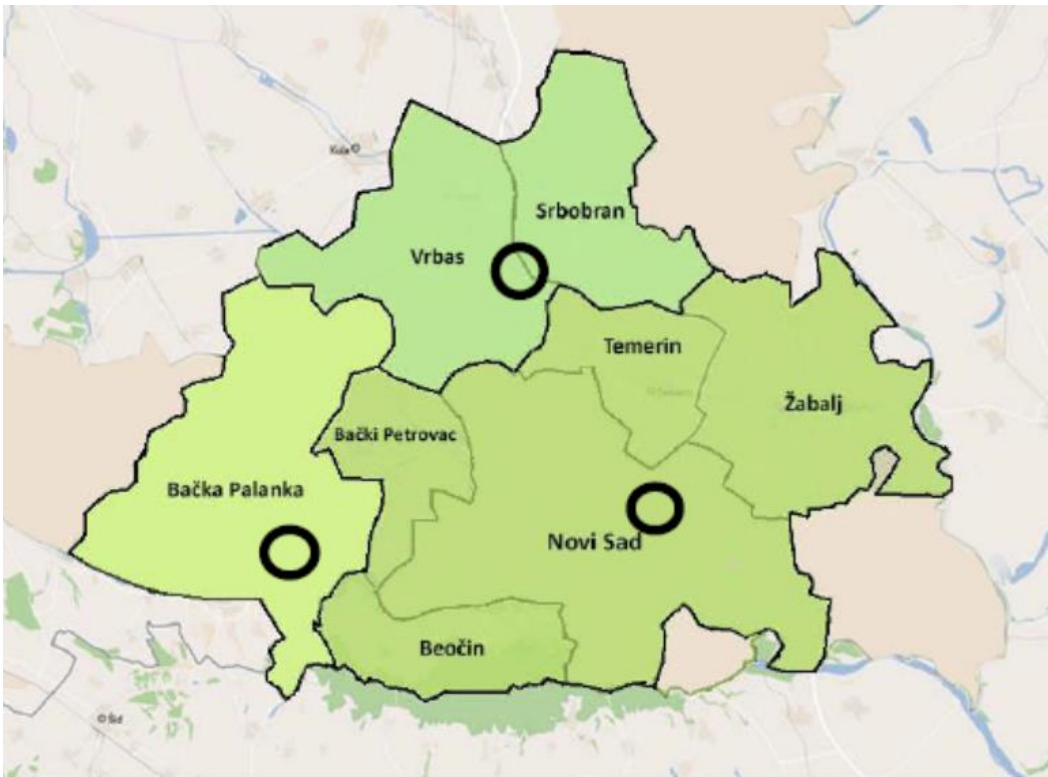

MSW that is going to be treated in RWMC

2025-2030 “Two bins” collection system

“dry” bin/container will contain recyclable waste that includes different types of materials suitable for recycling such as:

- plastic,
- paper and cardboard,
- metal,
- composite material,
- rubber, etc.

“wet” bin/container, all remaining municipal waste will be collected, which consists mostly of biodegradable waste categories (food residues and kitchen waste), as well as other fractions, such as

- textiles,
- leather,
- soil, etc.

from 2030 “Three bins” collection system

“bio-waste” bin/container for separately collected bio-waste from households and similar waste will be introduced.



RWMC Novi Sad - Location

Location of the existing and the planned Centre

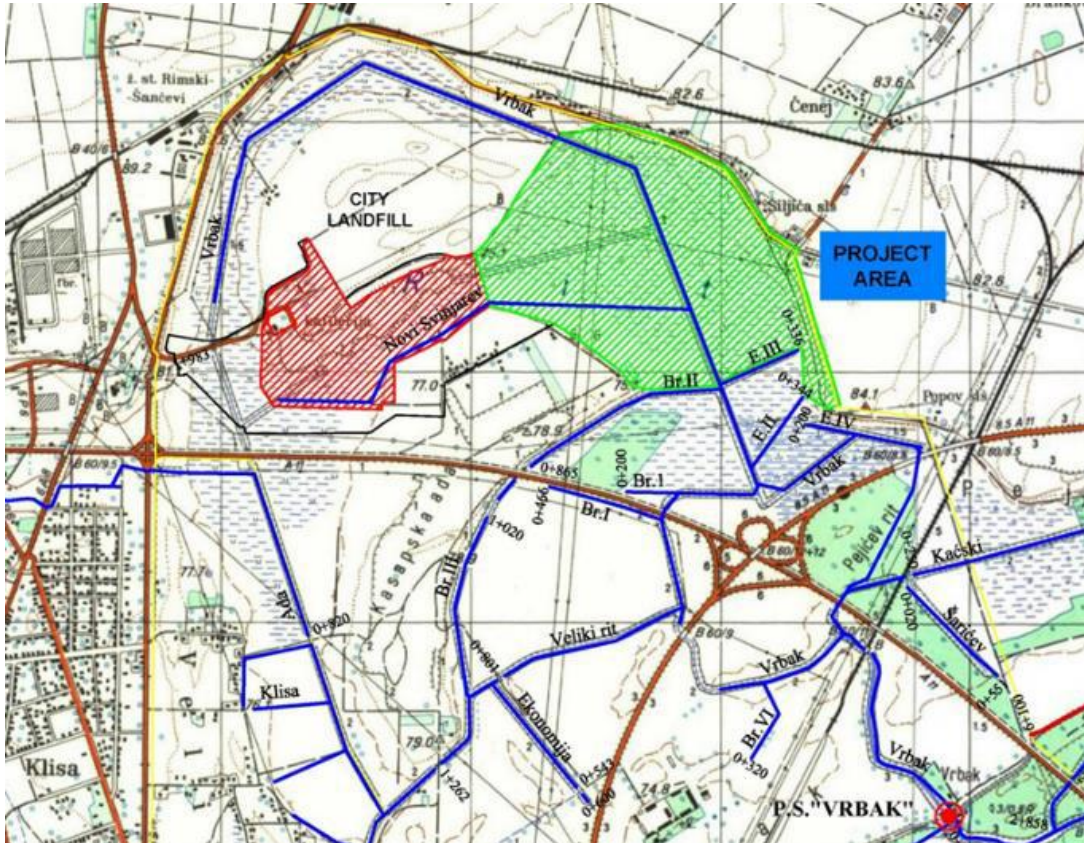

- Location is situated **about 6 km northern from the city center** and **about 700 m from the outskirts settlements of the city.**
- The RWMC shall be constructed in three phases. Only **Phase 1** is included in this Contract (Lot 1).
- All parcels which shall be used for construction of Phase 1 are **publicly owned**, by the state of RS or by the City of Novi Sad.



Scope of Work

The subject of the Contract shall be the design and construction of a Regional Waste Management Center (RWMC) in the City of Novi Sad comprising of two zones:

Working zone with Mechanical Biological Treatment Facility including following process plants:

- Material Recovery Facility,
- Bio-drying Plant,
- Refuse-Derived Fuel preparation Plant,
- Biogas Plant.

Landfill zone, including the following:

- Sanitary landfill (including LFG Extraction System and leachate drainage),
- Leachate Treatment Plant (LTP)

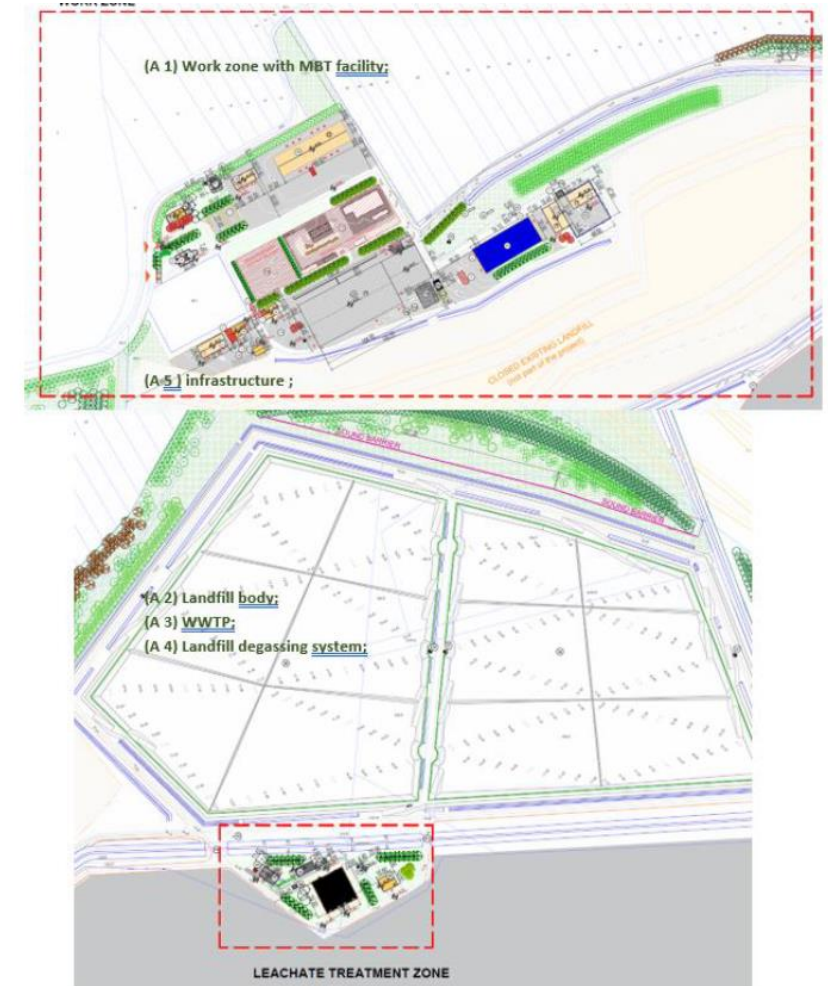

Scope of Work - Working zone



The following facilities and plants shall be located in the Working zone:

- Gatehouse,
- Weighbridges with Canopy and Weighbridge house;
- Administrative Building,
- Building for workers,
- Workshop,
- Warehouse,
- Canopy with plateau - Vehicle washing;
- **MBT-MRF** (Existing MRF Hall with two sorting lines – one sorting line shall be upgraded and the second shall be replaced)
- Two Halls for storage of balled waste and recyclables with the plateau for storage of balled waste and recyclables,
- Existing building for workers/waterhouse.
- **MBT-Bio-drying plant** (with Odour Control System) and **RDF preparation plant**;



Scope of Work - Working zone



- **MBT-Biogas plant** (Digester, Technical containers for biogas plant, Torch, Water tank, and Sludge tank).
- Treated waste storage hall;
- Garage for mechanization;
- Wheel washing system
- Existing Transformer Station;
- New Transformer Station (next to the MBT);
- Diesel generator;
- Technical water supply system (water well and fire-fighting water reservoir (including pumping station));
- PS for process wastewater;
- WWTP (SBR unit with PS);
- Oil separator;
- CAS/Recycling Yard (**out of LOT 1***);
- CDW treatment (**out of LOT 1***).

***Note: Construction of these buildings/structures is out of the scope of the Contract, but connections of them to all new utilities/services are within the Contract.**



Estimated household waste and similar waste by morphological composition in RWMS Novi Sad in 2030.

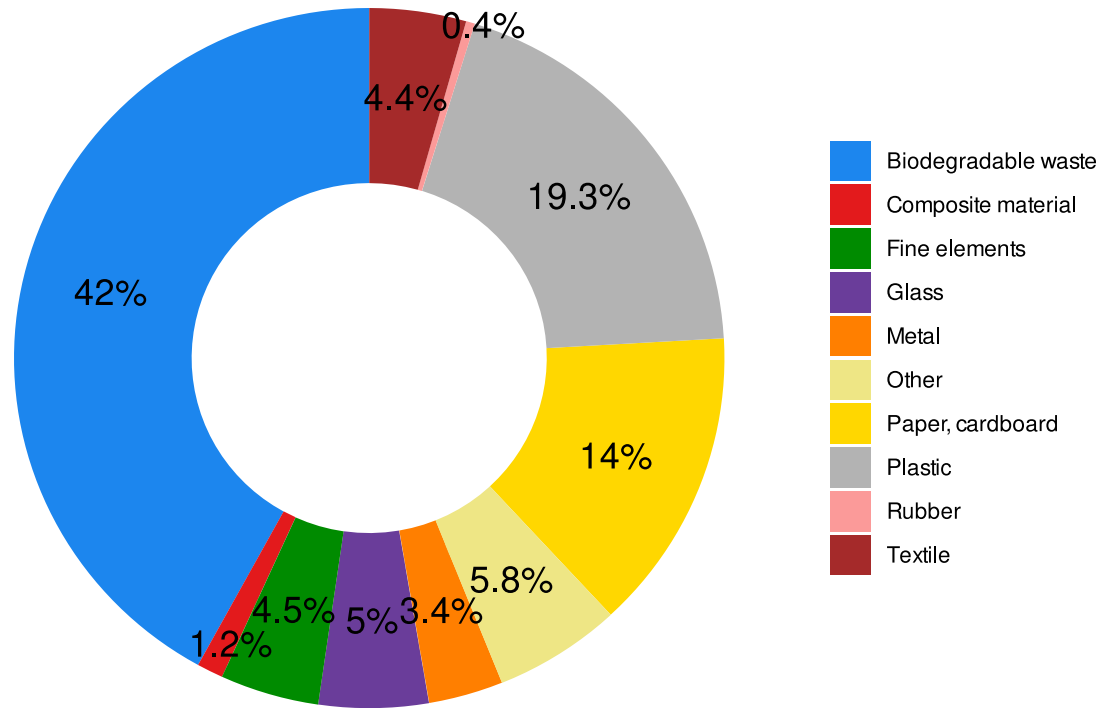

Projection for year 2030. Detailed data (projection) for the project period (till year 2053) are given in ER.

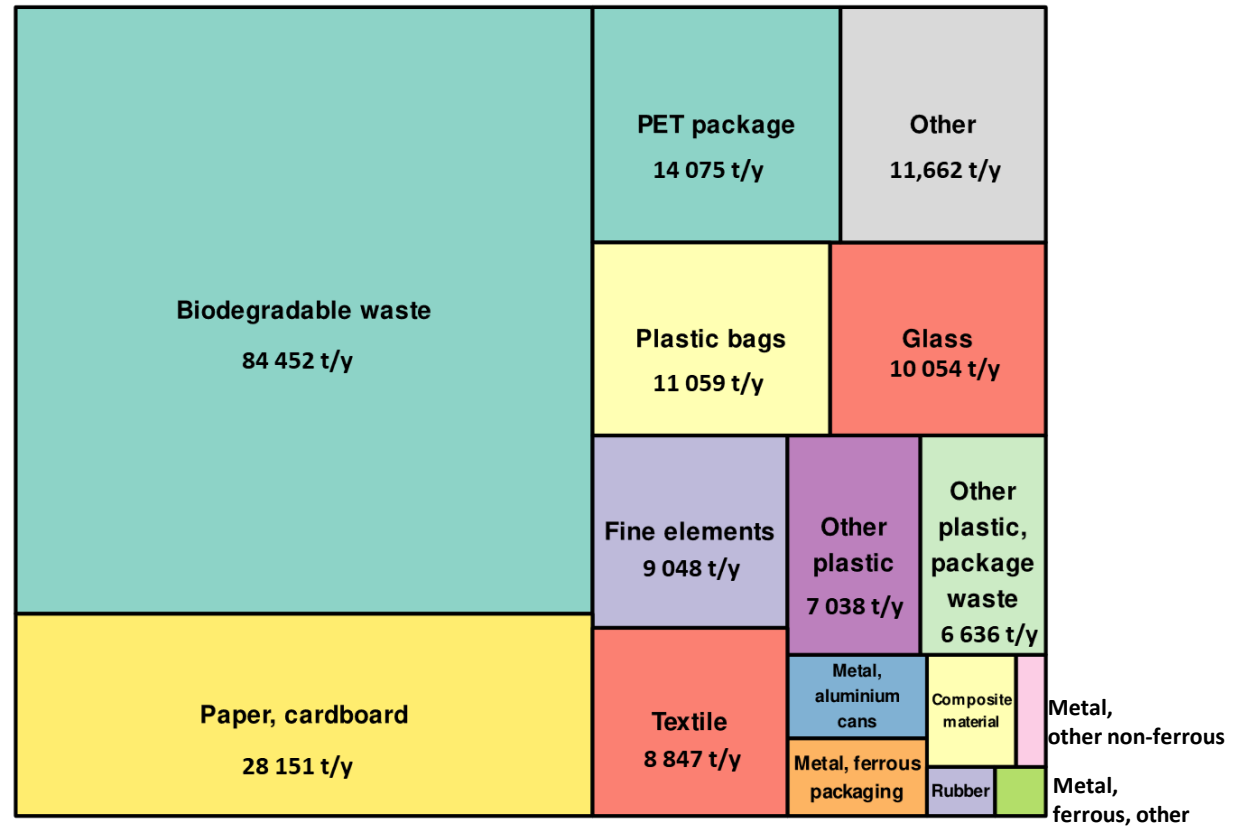

Working zone with MBT

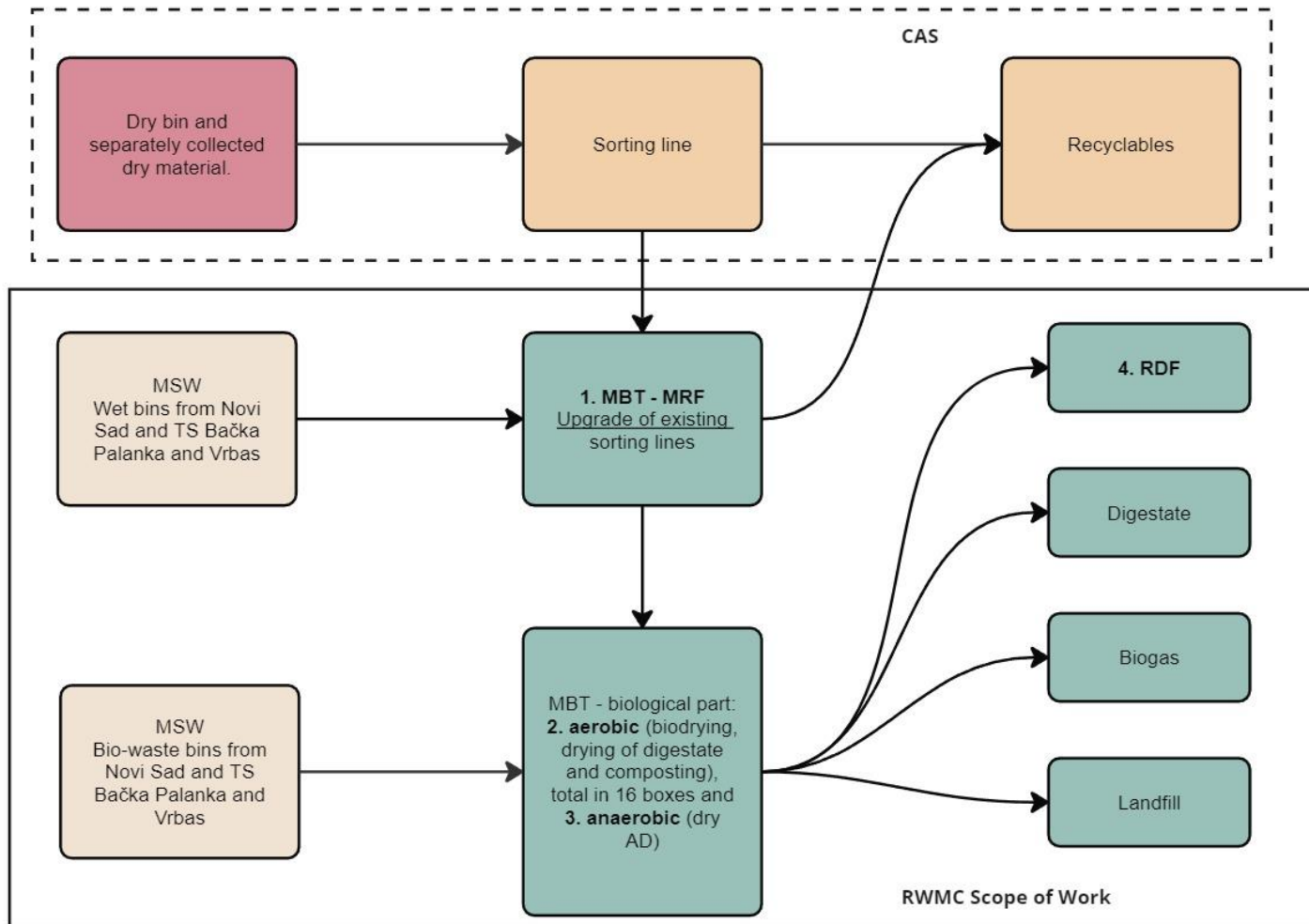

- Mechanical sorting - MRF** within the existing Hall for sorting (Building for waste sorting - existing) equipped with two sorting lines/MRFs, one existing that must be upgraded and one completely new sorting line;
- Biological treatment - aerobic treatment** in bio-drying tunnels;
- Biological treatment - dry Anaerobic Digestion** Biogas plant with CHP unit;
- Mechanical treatment**, separation of waste, dried in Bio-drying plant, as needed for preparation and storage of RDF.



1. Mechanical sorting - MRF

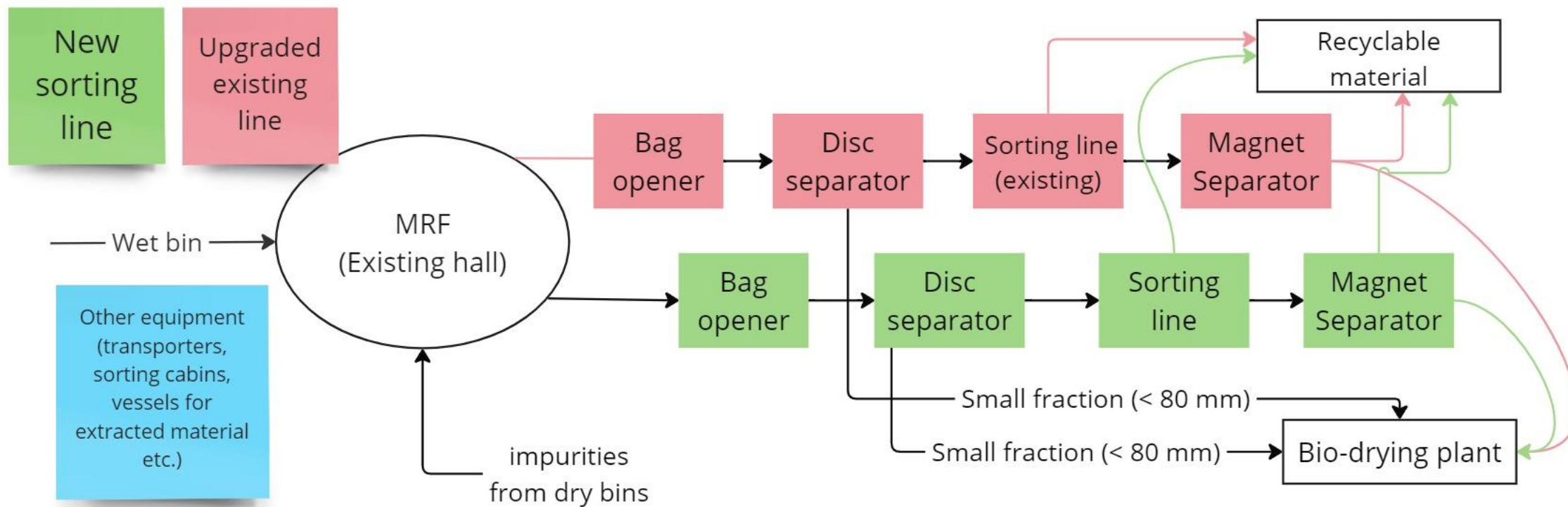

2. Bio-drying (aerobic treatment)

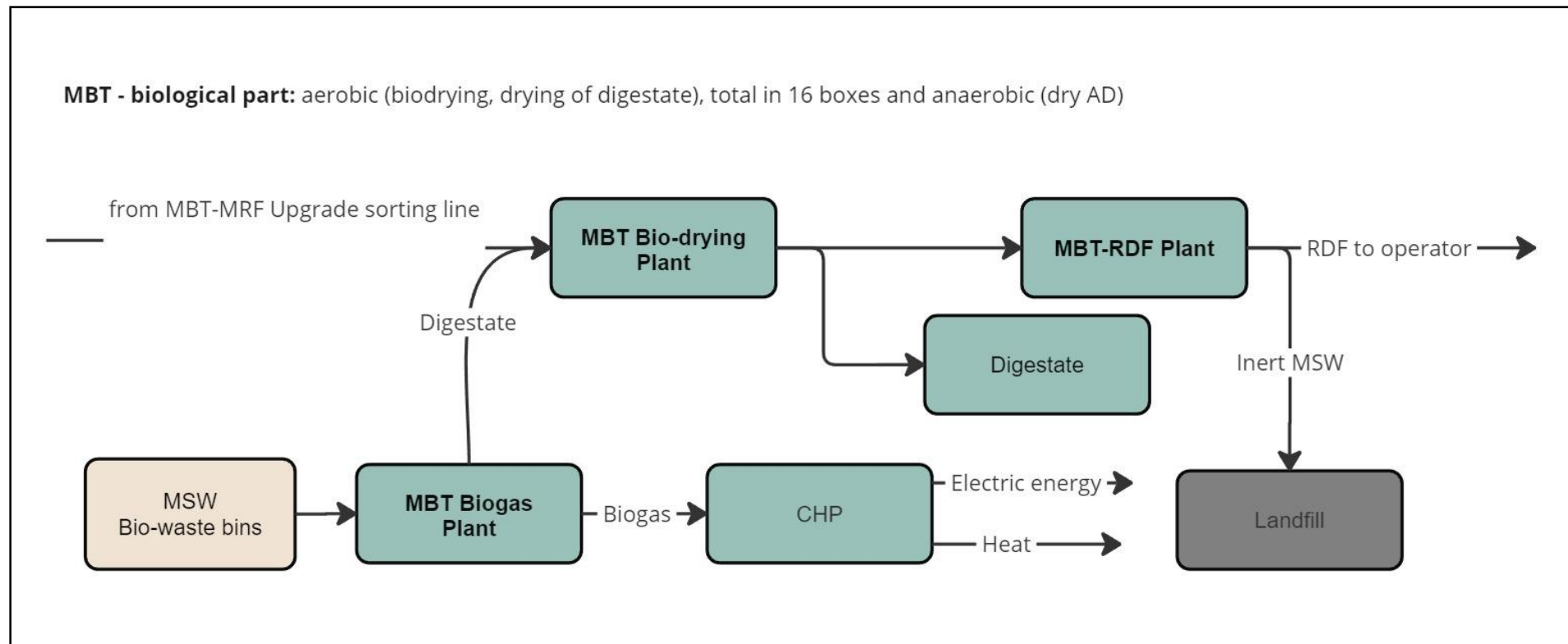

Odour System

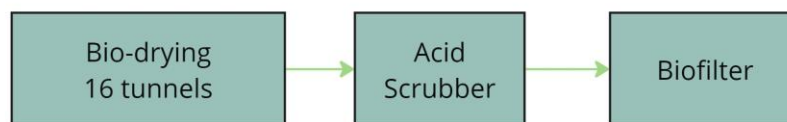

3. Biogas production (dry anaerobic Digestion)

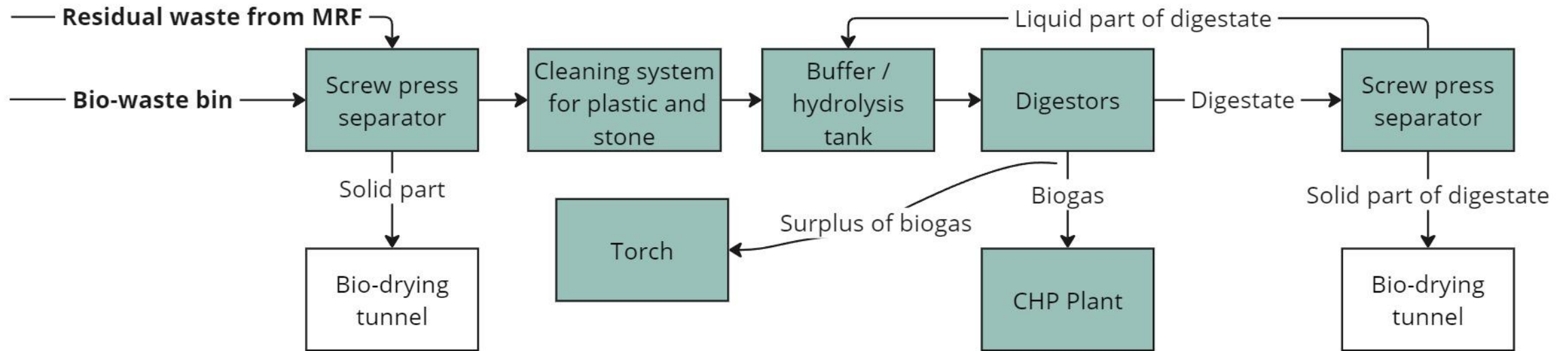

4. Preparation of RDF for storage and transport

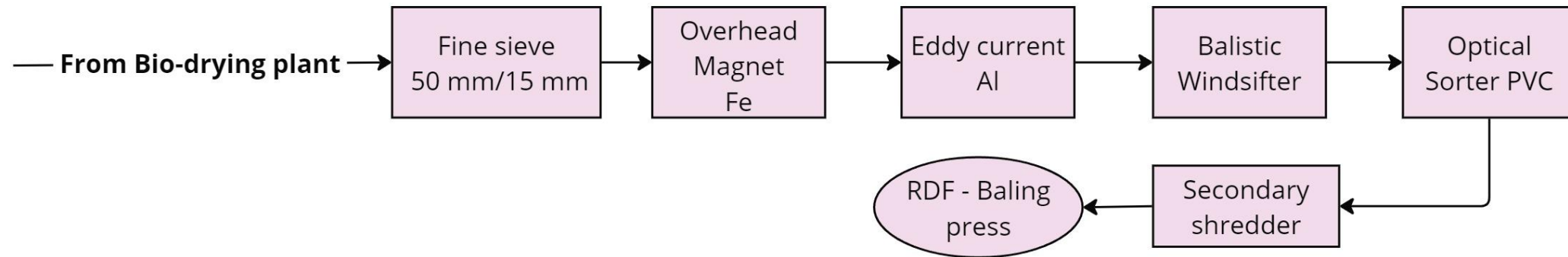

Output from RDF can be delivered to cement plants and inert waste which will be disposed of at landfill.



Scope of Work - Landfill zone

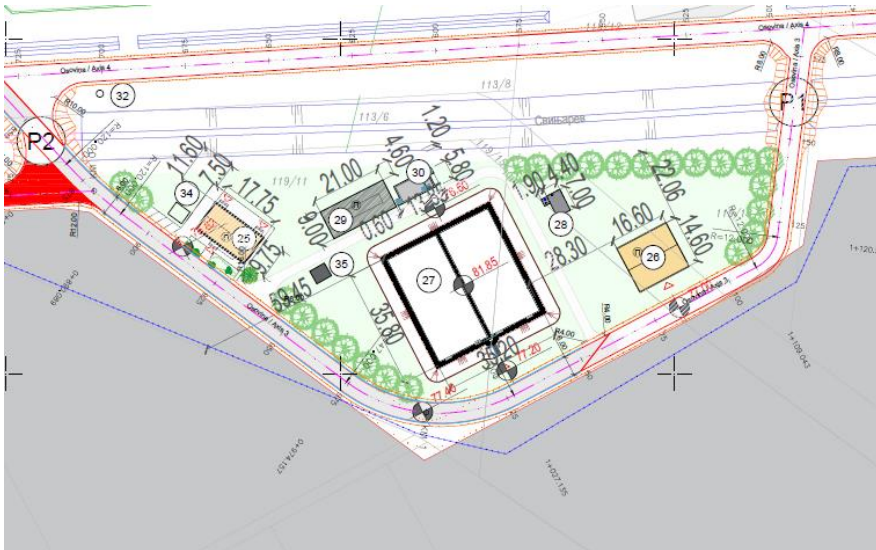
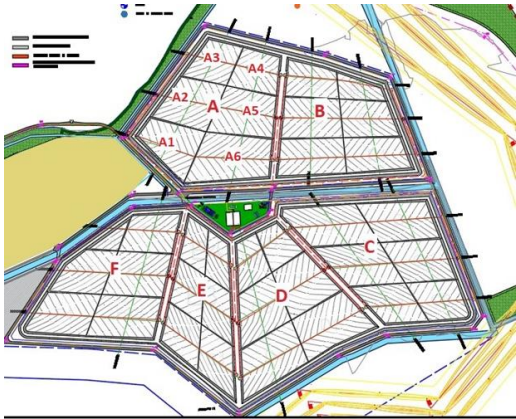

The following facilities and plants shall be located in the Landfill zone:

- Landfill cassettes with Leachate PSs;
- Leachate Retention Tank with receiving / distribution chamber
- Leachate treatment plant (LTP);
- Pumping station for leachate recirculation;
- Command building for LTP;
- Transformer Station;
- Diesel generator;
- Wastewater PS;
- Oil separator;
- Canopy for landfill mechanization;
- Sound barrier (toward the Nemanovci settlement)



Sanitary landfill for disposal of treatment residues and inert street waste

The total area of the landfill shall be 22.8 ha, divided into two cassettes (A and B), with capacities of 1,209,000 m³ and 941,000 m³, respectively. Calculated exploitation period is 39 years. **Cassette A shall be constructed in the Phase 1 (LOT 1)** and Cassette B is out of the project (included in Phase 2). South of these cells is area intended for further expansion of the landfill (cells C, D, E and F – Phase 3).

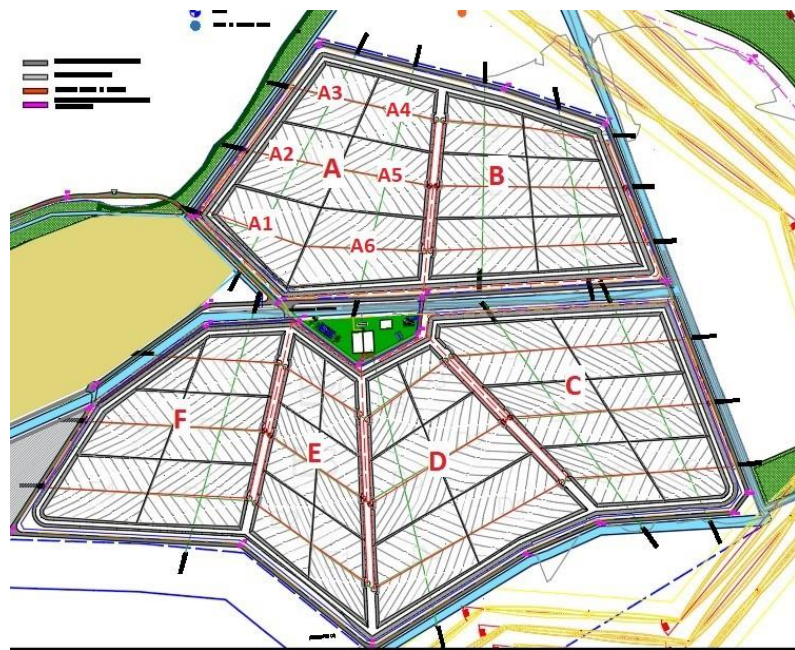

Landfill cassette*	Life time (y)	Capacity (m ³)
A (Phase 1)	13	1,209,000
B (Phase 2)	26	941,000
TOTAL	39	2,150,000

In accordance with Location conditions (No. 143-353-192/2021 of October 13, 2021, issued by the Secretariat for Energy, Construction and Traffic of AP Vojvodina), the **top level of landfill waste shall not be higher than 103.5 masl (sea level) including final cover.**

Construction of Cassette A shall include provision of leachate collection and LFG collection (Phase 1).



Sanitary landfill for disposal of treatment residues and inert street waste

Bottom lining system

- Prepared and compacted natural ground;
- Compacted soil (2 x 25 cm)
- Geo-synthetic clay – GCL ($\kappa \leq 1.0 \times 10^{-11}$ m/s);
- HDPE membrane integrity sensor network;
- HDPE membrane $d \geq 2.5$ mm thick;
- Geotextile of minimum 1,200 g/m²;
- 16-32 mm grading drainage gravel in a 50 cm thick layer.

Final cover system

The following layers are envisaged (from the bottom to the top):

- Inert leveling layer – 20 cm;
- Gas drainage layer (geosynthetic);
- Geosynthetic clay – GCL ($\kappa \leq 1.0 \times 10^{-11}$ m/s);
- Geocomposite drainage layer for atmospheric water drainage (waterproof HDPE core);
- Top soil for recultivation – 50 cm minimum with minimum 20 cm of humus.



Leachate and wastewater treatment

Considering different wastewater qualities, the RWMC shall provide separate treatment processes of the following:

- Leachate treatment (including leachate recirculation);
- Wastewater treatment;
- Stormwater treatment;

The **leachate** generated **at landfill and wastewater from MBT** and from **washing the floors** shall be collected and transferred to the LTP where it will be treated.

Sanitary wastewaters produced at the location shall be treated in WWTP unit for biological treatment of wastewater, based on SBR (Sequencing Batch Reactor) technology, after which they may be discharged to an open recipient.

Additionally, **surface water** from roads, plateaus and parking areas, potentially oiled and polluted, shall be collected and treated before discharge into recipients (meliorative channels). Stormwater treatment shall provide at least settling and oil separation in order to fulfil effluent quality requirements.



Leachate Treatment Plant (LTP)

Leachate Treatment Plant (LTP) shall consist of following functional parts:

- Mechanical pretreatment,
- Correction of pH value and
- Treatment on the three stage Reverse Osmosis (RO) units (including Cleaning-In-Place-CIP).

Mechanically treated leachate and process wastewater shall be reused (returned to the landfill by Pumping Station for Leachate Recirculation). Excess leachate and process wastewater shall be directed to the final treatment (three stage RO).

Permeate from the last stage of RO unit will be the final effluent, which shall be discharged into the recipient (open channel).



Landfill gas extraction system (Phase 1)

To prevent the spread of unpleasant odors and protect the environment, the project includes a landfill gas management system compliant with modern global regulations and best practices.

- **Vertical biothorns (Phase 1);**
- Equipment for connecting vertical biothorns to horizontal pipeline (Phase 2);
- A network of horizontal pipes for transport of landfill gas (Phase 2);
- Elements for extracting condensate (Phase 2);
- Landfill gas combustion unit (Phase 2).

Phase 1 of the project comprises only the construction of vertical biothorns (extendable build-up wells) for landfill **cassette 'A'**, as part of landfill gas collection system.

The design shall clearly present the future development of the landfill gas extraction and treatment system.



Scope of Works – Works relating to both zones of the RWMC

The works include design and construction of the following:

- Roads, plateaus and parking areas;
- Fencing and Gates;
- Electrical works, including Operation Control and SCADA system;
- HVAC
- All interconnecting piping/installations/cabling including manholes/chambers, culverts, discharge structures, open channels;
- Lanscaping.

For operation of the RWMC, the Contractor shall deliver Furniture and Laboratory Equipment.



The design and construction of Transfer Stations in Municipalities Vrbas and Bačka Palanka



REPUBLIC OF SERBIA
MINISTRY OF EUROPEAN INTEGRATION



TS Vrbas - Location



- Location of the **TS Vrbas** is situated at the south-eastern end of the town of Vrbas. The nearest houses are located at distance of about 350 m.
- TS shall be constructed in two phases. **Phase 1 (TS with CAS)** is included in this Contract (Lot 2). Construction of a Phase 2 (Composting plant is out of the scope of the Contract).
- All cadastral plots which shall be used for construction of Phase 1 are **publicly owned**.
- Total area foreseen for the construction of TS Vrbas (Phase 1) is **app. 1.2 ha** (within the boundary/fence of the complex).



TS Bačka Palanka - Location



- Location of the **TS Bačka Palanka** is situated at the eastern end of the town Bačka Palanka.
- All cadastral plots which shall be used for construction of Transfer station are **publicly owned**.
- Total area foreseen for the construction of TS Bačka Palanka is **app. 1 ha** (within the boundary/fence of the complex).



Scope of Work

The subject of the Contract shall be the design and construction of Transfer Stations in Municipalities Vrbas and Bačka Palanka.

Transfer Stations shall be designed and constructed to provide following waste managing operation: scaling, sorting, baling, storage (and takeover by registered recycling operators) and pressing of waste and transport to RWMC.

Each of TSs shall comprise of three technological (waste processing) zones:

- Zone of Transfer Station
- Zone of CAS (Civic Amenity Site) – collection of recyclable waste, HHW and other specific waste streams
- Zone of Center for sorting dry recyclable waste



Scope of Work

Each complex of Transfer Station shall contain the following:

- Weighbridge
- Gatehouse/Weighbridge house,
- Transshipment station (including abrol containers),
- Canopy for secondary raw materials,
- Storage for HHW (special container),
- Container for disposal of electrical and electronic waste,
- Storage for bulk waste,
- Hall for waste sorting,
- Canopy for baled waste,
- Building for workers,
- Transformer Station (Pillar in TS Vrbas; Prefabricated in TS Bačka Palanka)
- Diesel generator;
- Technical water supply system (including water well, fire-fighting and technical water tanks and pumping stations,
- Wastewater storage tanks,
- Oil separator,
- Other structures/facilities (**specifically for the TS Vrbas**: 2 retaining walls; open channel for collection of surface water)
- Roads, parking areas and plateaus,
- Fencing and Gates,
- Landscaping,
- Electrical works, including Operation Control and SCADA system;
- HVAC
- All interconnecting piping/installations/cabling including manholes/chambers, culverts, discharge structures.



Transshipment station (reloading ramp)

Transshipment station shall include the following:

- **Stationary press**, with complete hydraulics, electronics with PLC, hopper, control cabin and canopy above discharge zone;
- **System for rolo-container moving** with railings, wagons, rails and motors;
- **Closed containers** 32 m³ for stationary press (5 pieces).



Material flow – Sorting lines (dry bin – 20 t/day)

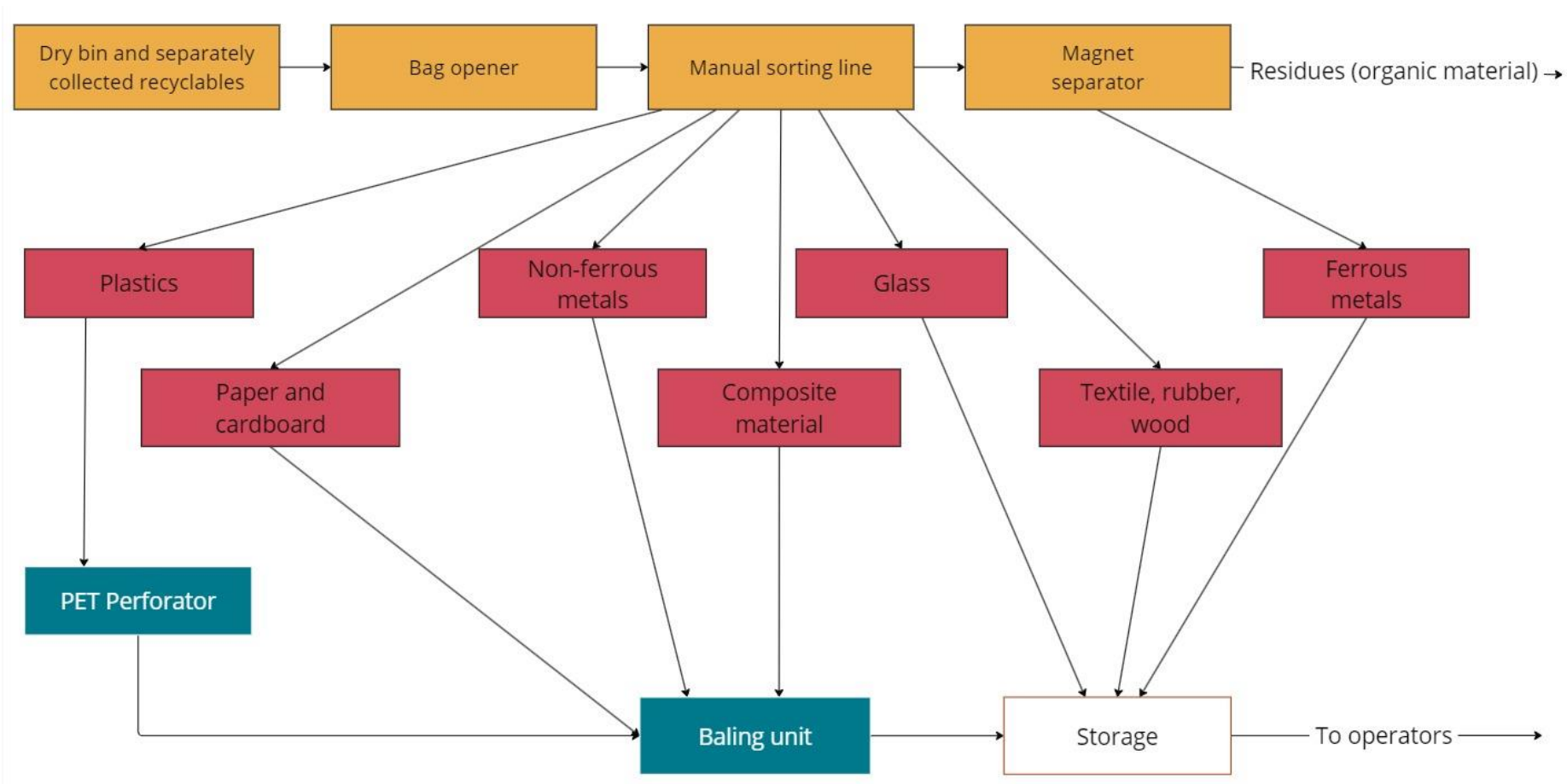

Material flow - Transshipment stations (60 t/day)

